

Specifications

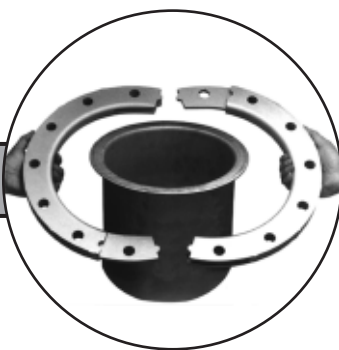

MARZOLF™ 2-Piece



Back-Up Flanges

**THE
MARZOLF
COMPANY**

POST OFFICE BOX 281
N8705 COUNTY ROAD W, RIVER FALLS, WI 54022
PHONE > 715.426.5705 | FAX > 715.426.5708
E-MAIL > INFO@MARZOLF.COM
WWW.MARZOLF.COM

SINCE 1955 | MADE IN THE USA

QUICK AND SIMPLE

Quickly and simply make permanent flange replacements with the **MARZOLF** two-piece flange. Its unique two-piece design eliminates the need to cut and reweld pipes when changing flanges.

REDUCES DOWN TIME – SAVES MONEY

When you shut down your line to replace slip on or lap joint flanges, your equipment is not producing. The unique two-piece design of the **MARZOLF** back-up flange eliminates the need to cut and reweld Van Stone style pipes ends. This feature expedites the repair, to reduce down time.

UNIQUE DESIGN PROMOTES EFFICIENCY, STRENGTH

George B. Marzolf, Sr. invented the two-piece back-up flange in 1955 and was granted a patent in 1959. His unique design utilizes multiple laminae which offset to create complementary male and female ends on each half ring. These half rings slide into one another as the flange halves are brought together creating rigidity equivalent to one piece rings. When together, the two halves share common bolt holes which effectively disperse bolting pressure to provide a uniform seal.

MARZOLF two-piece back-up flanges go on after your pipes are in place.

Result: Less weight to handle, lower risk of injury, more efficient installation and replacement.

NEW PRODUCTS

NEW! CLASS 75 AND CLASS 150 flange thicknesses

NEW! FITSCLIP instantly clips flange halves together during installation

NEW! E-COAT epoxy coating

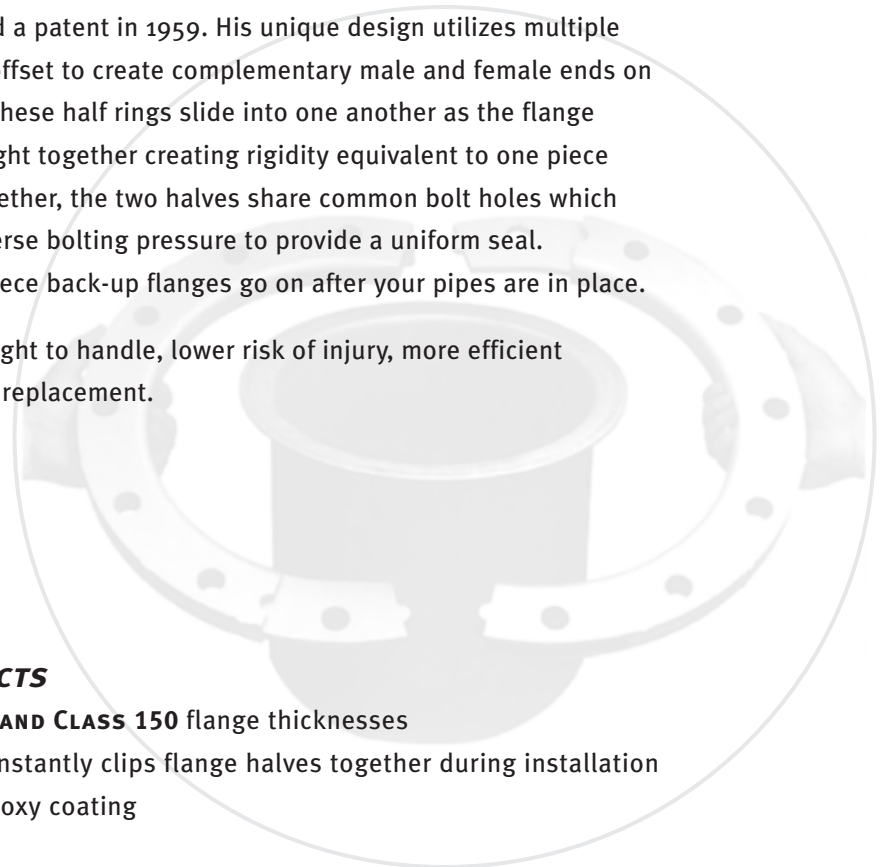

TABLE OF CONTENTS

T-316L STAINLESS STEEL

CLASS 75 (CLASS 150 BOLT HOLE PATTERN)

Sized to Fit Tube Stub End	1
Sized to Fit Tube Angle Face Ring	3
Sized to Fit Types B & C Pipe Stub End	5
Sized to Fit Type A Stub Ends & Polyethylene Pipe	7
Sized to Fit Pipe Angle Face Ring	9

CLASS 150 BOLT HOLE PATTERN

Sized to Fit Tube Stub End	2
Sized to Fit Tube Angle Face Ring	4
Sized to Fit Types B & C Pipe Stub End	6
Sized to Fit Type A Stub Ends & Polyethylene Pipe	8
Sized to Fit Pipe Angle Face Ring	10

CLASS 300 BOLT HOLE PATTERN

Sized to Fit Class 300 Bolt Hole Pattern	21
--	----

ZINC PLATED CARBON STEEL

CLASS 75 (CLASS 150 BOLT HOLE PATTERN)

Sized to Fit Tube Stub End	11
Sized to Fit Tube Angle Face Ring	13
Sized to Fit Types B & C Pipe Stub End	15
Sized to Fit Type A Stub Ends & Polyethylene Pipe	17
Sized to Fit Pipe Angle Face Ring	19

CLASS 150 BOLT HOLE PATTERN

Sized to Fit Tube Stub End	12
Sized to Fit Tube Angle Face Ring	14
Sized to Fit Types B & C Pipe Stub End	16
Sized to Fit Type A Stub Ends & Polyethylene Pipe	18
Sized to Fit Pipe Angle Face Ring	20

CLASS 300 BOLT HOLE PATTERN

Sized to Fit Class 300 Bolt Hole Pattern	22
--	----

DIAGRAMS

Recommended Bolting Sequence	23
Common Terminology	24

T-316L Stainless Steel — For OD Tube Stub Ends

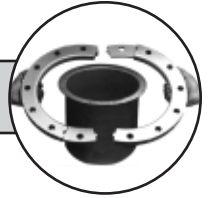

• **Class 75** •

Size	Part No.	Inside Diameter I.D.	Outside Diameter O.D.	Thickness T.	Bolt Circle B.C.	Holes H.D.		Bolts		Plies		Shipping Weight Lbs.
						No.	Dia.	No.	Size	No.	Ga.	
3/4"	3612-STD	7/8"	3-1/2"	3/8"	2-3/8"	4	5/8"	4	1/2"	3	1/8"	1
1"	3602-STD	1-1/8"	3-7/8"	3/8"	2-3/4"	4	5/8"	4	1/2"	3	1/8"	1-1/4
1-1/4"	3572-STD	1-3/8"	4-1/4"	1/2"	3-1/8"	4	5/8"	4	1/2"	4	1/8"	1-3/4
1-1/2"	3582-STD	1-3/4"	4-5/8"	1/2"	3-1/2"	4	5/8"	4	1/2"	4	1/8"	2
1-3/4"	3592-STD	2"	5"	1/2"	3-7/8"	4	5/8"	4	1/2"	4	1/8"	2-1/4
2"	2682-STD	2-3/8"	6"	1/2"	4-3/4"	4	3/4"	4	5/8"	4	1/8"	3-1/4
2-1/2"	1822-STD	2-7/8"	7"	1/2"	5-1/2"	4	3/4"	4	5/8"	4	1/8"	4-1/4
3"	1722-STD	3-3/8"	7-1/2"	1/2"	6"	4	3/4"	4	5/8"	4	1/8"	4-3/4
4"	1492-STD	4-3/8"	9"	1/2"	7-1/2"	8	3/4"	8	5/8"	4	1/8"	6-1/4
5"	2922-STD	5-3/8"	10"	1/2"	8-1/2"	8	7/8"	8	3/4"	4	1/8"	6-3/4
6"	1262-STD	6-3/8"	11"	1/2"	9-1/2"	8	7/8"	8	3/4"	4	1/8"	7-3/4
8"	1442-STD	8-3/8"	13-1/2"	1/2"	11-3/4"	8	7/8"	8	3/4"	4	1/8"	11-1/2
10"	1502-STD	10-3/8"	16"	5/8"	14-1/4"	12	1"	12	7/8"	5	1/8"	18-1/2
12"	1522-STD	12-3/8"	19"	5/8"	17"	12	1"	12	7/8"	5	1/8"	25-3/4
14"	1842-STD	14-1/2"	21"	7/8"	18-3/4"	12	1-1/8"	12	1"	7	1/8"	42
16"	1752-STD	16-1/2"	23-1/2"	7/8"	21-1/4"	16	1-1/8"	16	1"	7	1/8"	50
18"	1762-STD	18-1/2"	25"	7/8"	22-3/4"	16	1-1/4"	16	1-1/8"	7	1/8"	53
20"	1772-STD	20-1/2"	27-1/2"	7/8"	25"	20	1-1/4"	20	1-1/8"	7	1/8"	63
24"	3252-STD	24-3/4"	32"	1-1/4"	29-1/2"	20	1-3/8"	20	1-1/4"	10	1/8"	104
30"	3262-STD	30-3/4"	38-3/4"	1-1/4"	36"	28	1-3/8"	28	1-1/4"	10	1/8"	139

**THE
MARZOLF
COMPANY**

PHONE 715.426.5705 | FAX 715.426.5708

E-MAIL INFO@MARZOLF.COM

WWW.MARZOLF.COM

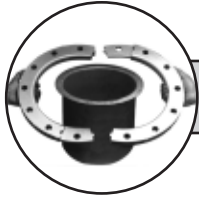

T-316L Stainless Steel — For OD Tube Stub Ends

• Class 150 •

Size	Part No.	Inside Diameter I.D.	Outside Diameter O.D.	Thickness T.	Bolt Circle B.C.	Holes H.D.		Bolts		Plies		Shipping Weight Lbs.
						No.	Dia.	No.	Size	No.	Ga.	
3/4"	3612-3/8-STD	7/8"	3-1/2"	3/8"	2-3/8"	4	5/8"	4	1/2"	3	1/8"	1
1"	3602-4/8-STD	1-1/8"	3-7/8"	1/2"	2-3/4"	4	5/8"	4	1/2"	4	1/8"	1-1/2
1-1/4"	3572-4/8-STD	1-3/8"	4-1/4"	1/2"	3-1/8"	4	5/8"	4	1/2"	4	1/8"	1-3/4
1-1/2"	3582-5/8-STD	1-3/4"	4-5/8"	5/8"	3-1/2"	4	5/8"	4	1/2"	5	1/8"	2-1/2
1-3/4"	3592-5/8-STD	2"	5"	5/8"	3-7/8"	4	5/8"	4	1/2"	5	1/8"	2-3/4
2"	2682-6/8-STD	2-3/8"	6"	3/4"	4-3/4"	4	3/4"	4	5/8"	6	1/8"	4-1/2
2-1/2"	1822-7/8-STD	2-7/8"	7"	7/8"	5-1/2"	4	3/4"	4	5/8"	7	1/8"	7-1/2
3"	1722-7/8-STD	3-3/8"	7-1/2"	7/8"	6"	4	3/4"	4	5/8"	7	1/8"	10-1/2
4"	1492-7/8-STD	4-3/8"	9"	7/8"	7-1/2"	8	3/4"	8	5/8"	7	1/8"	13-1/4
5"	2922-7/8-STD	5-3/8"	10"	7/8"	8-1/2"	8	7/8"	8	3/4"	7	1/8"	14-1/2
6"	1262-8/8-STD	6-3/8"	11"	1"	9-1/2"	8	7/8"	8	3/4"	8	1/8"	16-1/2
8"	1442-9/8-STD	8-3/8"	13-1/2"	1-1/8"	11-3/4"	8	7/8"	8	3/4"	3	3/8"	24-1/2
10"	1502-12/8-STD	10-3/8"	16"	1-1/2"	14-1/4"	12	1"	12	7/8"	4	3/8"	44-1/2
12"	1522-12/8-STD	12-3/8"	19"	1-1/2"	17"	12	1"	12	7/8"	4	3/8"	62
14"	1842-12/8-STD	14-1/2"	21"	1-1/2"	18-3/4"	12	1-1/8"	12	1"	4	3/8"	72
16"	1752-12/8-STD	16-1/2"	23-1/2"	1-1/2"	21-1/4"	16	1-1/8"	16	1"	4	3/8"	86
18"	1762-12/8-STD	18-1/2"	25"	1-1/2"	22-3/4"	16	1-1/4"	16	1-1/8"	4	3/8"	91
20"	1772-15/8-STD	20-1/2"	27-1/2"	1-7/8"	25"	20	1-1/4"	20	1-1/8"	5	3/8"	135
24"	3252-15/8-STD	24-3/4"	32"	1-7/8"	29-1/2"	20	1-3/8"	20	1-1/4"	5	3/8"	156
30"	3262-18/8-STD	30-3/4"	38-3/4"	2-1/4"	36"	28	1-3/8"	28	1-1/4"	6	3/8"	250

T-316L Stainless Steel — For OD Tube Stub Ends



PHONE 715.426.5705 | FAX 715.426.5708
 E-MAIL INFO@MARZOLF.COM
 WWW.MARZOLF.COM

T-316L Stainless Steel — For OD Tube Angle Face Rings

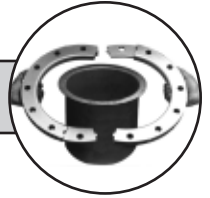

• **Class 75** •

Size	Part No.	Inside Diameter I.D.	Outside Diameter O.D.	Thickness T.	Bolt Circle B.C.	Holes H.D.		Bolts		Plies		Shipping Weight Lbs.
						No.	Dia.	No.	Size	No.	Ga.	
3/4"	3612-TAFR	7/8"	3-1/2"	3/8"	2-3/8"	4	5/8"	4	1/2"	3	1/8"	1
1"	3602-TAFR	1-1/8"	3-7/8"	3/8"	2-3/4"	4	5/8"	4	1/2"	3	1/8"	1-1/4
1-1/4"	3572-TAFR	1-3/8"	4-1/4"	1/2"	3-1/8"	4	5/8"	4	1/2"	4	1/8"	1-3/4
1-1/2"	3582-TAFR	1-3/4"	4-5/8"	1/2"	3-1/2"	4	5/8"	4	1/2"	4	1/8"	2
1-3/4"	3592-TAFR	2"	5"	1/2"	3-7/8"	4	5/8"	4	1/2"	4	1/8"	2-1/4
2"	2682-TAFR	2-1/2"	6"	1/2"	4-3/4"	4	3/4"	4	5/8"	4	1/8"	3
2-1/2"	1822-TAFR	3"	7"	1/2"	5-1/2"	4	3/4"	4	5/8"	4	1/8"	4
3"	1722-TAFR	3-5/8"	7-1/2"	1/2"	6"	4	3/4"	4	5/8"	4	1/8"	4-1/2
4"	1492-TAFR	4-5/8"	9"	1/2"	7-1/2"	8	3/4"	8	5/8"	4	1/8"	6
5"	2922-TAFR	5-11/16"	10"	1/2"	8-1/2"	8	7/8"	8	3/4"	4	1/8"	6-1/2
6"	1262-TAFR	6-3/4"	11"	1/2"	9-1/2"	8	7/8"	8	3/4"	4	1/8"	7-1/2
8"	1442-TAFR	8-3/4"	13-1/2"	1/2"	11-3/4"	8	7/8"	8	3/4"	4	1/8"	10-1/2
10"	1502-TAFR	10-7/8"	16"	5/8"	14-1/4"	12	1"	12	7/8"	5	1/8"	16-3/4
12"	1522-TAFR	12-7/8"	19"	5/8"	17"	12	1"	12	7/8"	5	1/8"	24
14"	1842-TAFR	14-3/4"	21"	7/8"	18-3/4"	12	1-1/8"	12	1"	7	1/8"	41
16"	1752-TAFR	16-3/4"	23-1/2"	7/8"	21-1/4"	16	1-1/8"	16	1"	7	1/8"	49
18"	1762-TAFR	18-3/4"	25"	7/8"	22-3/4"	16	1-1/4"	16	1-1/8"	7	1/8"	51
20"	1772-TAFR	20-3/4"	27-1/2"	7/8"	25"	20	1-1/4"	20	1-1/8"	7	1/8"	61
24"	3252-TAFR	24-7/8"	32"	1-1/4"	29-1/2"	20	1-3/8"	20	1-1/4"	10	1/8"	102
30"	3262-TAFR	30-7/8"	38-3/4"	1-1/4"	36"	28	1-3/8"	28	1-1/4"	10	1/8"	137

**THE
MARZOLF
COMPANY**

PHONE 715.426.5705 | FAX 715.426.5708

E-MAIL INFO@MARZOLF.COM

WWW.MARZOLF.COM

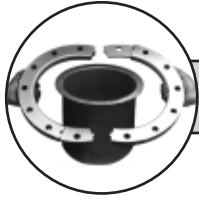

T-316L Stainless Steel — For OD Tube Angle Face Rings

• Class 150 •

Size	Part No.	Inside Diameter I.D.	Outside Diameter O.D.	Thickness T.	Bolt Circle B.C.	Holes H.D.		Bolts		Plies		Shipping Weight Lbs.
						No.	Dia.	No.	Size	No.	Ga.	
3/4"	3612-3/8-TAFR	7/8"	3-1/2"	3/8"	2-3/8"	4	5/8"	4	1/2"	3	1/8"	1
1"	3602-4/8-TAFR	1-1/8"	3-7/8"	1/2"	2-3/4"	4	5/8"	4	1/2"	4	1/8"	1-1/2
1-1/4"	3572-4/8-TAFR	1-3/8"	4-1/4"	1/2"	3-1/8"	4	5/8"	4	1/2"	4	1/8"	1-3/4
1-1/2"	3582-5/8-TAFR	1-3/4"	4-5/8"	5/8"	3-1/2"	4	5/8"	4	1/2"	5	1/8"	2-1/2
1-3/4"	3592-5/8-TAFR	2"	5"	5/8"	3-7/8"	4	5/8"	4	1/2"	5	1/8"	2-3/4
2"	2682-6/8-TAFR	2-1/2"	6"	3/4"	4-3/4"	4	3/4"	4	5/8"	6	1/8"	4-1/2
2-1/2"	1822-7/8-TAFR	3"	7"	7/8"	5-1/2"	4	3/4"	4	5/8"	7	1/8"	7-1/2
3"	1722-7/8-TAFR	3-5/8"	7-1/2"	7/8"	6"	4	3/4"	4	5/8"	7	1/8"	10-1/2
4"	1492-7/8-TAFR	4-5/8"	9"	7/8"	7-1/2"	8	3/4"	8	5/8"	7	1/8"	13-1/4
5"	2922-7/8-TAFR	5-11/16"	10"	7/8"	8-1/2"	8	7/8"	8	3/4"	7	1/8"	14-1/2
6"	1262-8/8-TAFR	6-3/4"	11"	1"	9-1/2"	8	7/8"	8	3/4"	8	1/8"	16-1/2
8"	1442-9/8-TAFR	8-3/4"	13-1/2"	1-1/8"	11-3/4"	8	7/8"	8	3/4"	3	3/8"	24-1/2
10"	1502-12/8-TAFR	10-7/8"	16"	1-1/2"	14-1/4"	12	1"	12	7/8"	4	3/8"	44-1/2
12"	1522-12/8-TAFR	12-7/8"	19"	1-1/2"	17"	12	1"	12	7/8"	4	3/8"	62
14"	1842-12/8-TAFR	14-3/4"	21"	1-1/2"	18-3/4"	12	1-1/8"	12	1"	4	3/8"	72
16"	1752-12/8-TAFR	16-3/4"	23-1/2"	1-1/2"	21-1/4"	16	1-1/8"	16	1"	4	3/8"	86
18"	1762-12/8-TAFR	18-3/4"	25"	1-1/2"	22-3/4"	16	1-1/4"	16	1-1/8"	4	3/8"	91
20"	1772-15/8-TAFR	20-3/4"	27-1/2"	1-7/8"	25"	20	1-1/4"	20	1-1/8"	5	3/8"	135
24"	3252-15/8-TAFR	24-7/8"	32"	1-7/8"	29-1/2"	20	1-3/8"	20	1-1/4"	5	3/8"	156
30"	3262-18/8-TAFR	30-7/8"	38-3/4"	2-1/4"	36"	28	1-3/8"	28	1-1/4"	6	3/8"	250

THE MARZOLF COMPANY

PHONE 715.426.5705 | FAX 715.426.5708

E-MAIL INFO@MARZOLF.COM

WWW.MARZOLF.COM

T-316L Stainless Steel — For OD Tube Angle Face Rings

T-316L Stainless Steel — For Types B & C Pipe Stub Ends

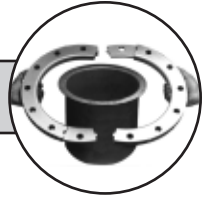

• **Class 75** •

Size	Part No.	Inside Diameter I.D.	Outside Diameter O.D.	Thickness T.	Bolt Circle B.C.	Holes H.D.		Bolts		Plies		Shipping Weight Lbs.
						No.	Dia.	No.	Size	No.	Ga.	
1/2"	3612-IPS	7/8"	3-1/2"	3/8"	2-3/8"	4	5/8"	4	1/2"	3	1/8"	1
3/4"	3602-IPS	1-1/8"	3-7/8"	3/8"	2-3/4"	4	5/8"	4	1/2"	3	1/8"	1-1/4
1"	3572-IPS	1-3/8"	4-1/4"	1/2"	3-1/8"	4	5/8"	4	1/2"	4	1/8"	1-3/4
1-1/4"	3582-IPS	1-3/4"	4-5/8"	1/2"	3-1/2"	4	5/8"	4	1/2"	4	1/8"	2
1-1/2"	3592-IPS	2"	5"	1/2"	3-7/8"	4	5/8"	4	1/2"	4	1/8"	2-1/4
2"	2682-IPS	2-1/2"	6"	1/2"	4-3/4"	4	3/4"	4	5/8"	4	1/8"	3
2-1/2"	1822-IPS	3"	7"	1/2"	5-1/2"	4	3/4"	4	5/8"	4	1/8"	4
3"	1722-IPS	3-5/8"	7-1/2"	1/2"	6"	4	3/4"	4	5/8"	4	1/8"	4-1/2
4"	1492-IPS	4-5/8"	9"	1/2"	7-1/2"	8	3/4"	8	5/8"	4	1/8"	6
5"	2922-IPS	5-11/16"	10"	1/2"	8-1/2"	8	7/8"	8	3/4"	4	1/8"	6-1/2
6"	1262-IPS	6-3/4"	11"	1/2"	9-1/2"	8	7/8"	8	3/4"	4	1/8"	7-1/2
8"	1442-IPS	8-3/4"	13-1/2"	1/2"	11-3/4"	8	7/8"	8	3/4"	4	1/8"	10-1/2
10"	1502-IPS	10-7/8"	16"	5/8"	14-1/4"	12	1"	12	7/8"	5	1/8"	16-3/4
12"	1522-IPS	12-7/8"	19"	5/8"	17"	12	1"	12	7/8"	5	1/8"	24
14"	1842-IPS	14-1/2"	21"	7/8"	18-3/4"	12	1-1/8"	12	1"	7	1/8"	42
16"	1752-IPS	16-1/2"	23-1/2"	7/8"	21-1/4"	16	1-1/8"	16	1"	7	1/8"	50
18"	1762-IPS	18-1/2"	25"	7/8"	22-3/4"	16	1-1/4"	16	1-1/8"	7	1/8"	53
20"	1772-IPS	20-1/2"	27-1/2"	7/8"	25"	20	1-1/4"	20	1-1/8"	7	1/8"	63
24"	3252-IPS	24-3/4"	32"	1-1/4"	29-1/2"	20	1-3/8"	20	1-1/4"	10	1/8"	104
30"	3262-IPS	30-3/4"	38-3/4"	1-1/4"	36"	28	1-3/8"	28	1-1/4"	10	1/8"	139

**THE
MARZOLF
COMPANY**

PHONE 715.426.5705 | FAX 715.426.5708

E-MAIL INFO@MARZOLF.COM

WWW.MARZOLF.COM

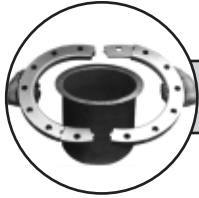

T-316L Stainless Steel — For Types B & C Pipe Stub Ends

• Class 150 •

Size	Part No.	Inside Diameter I.D.	Outside Diameter O.D.	Thickness T.	Bolt Circle B.C.	Holes H.D.		Bolts		Plies		Shipping Weight Lbs.
						No.	Dia.	No.	Size	No.	Ga.	
1/2"	3612-3/8-IPS	7/8"	3-1/2"	3/8"	2-3/8"	4	5/8"	4	1/2"	3	1/8"	1
3/4"	3602-4/8-IPS	1-1/8"	3-7/8"	1/2"	2-3/4"	4	5/8"	4	1/2"	4	1/8"	1-1/2
1"	3572-4/8-IPS	1-3/8"	4-1/4"	1/2"	3-1/8"	4	5/8"	4	1/2"	4	1/8"	1-3/4
1-1/4"	3582-5/8-IPS	1-3/4"	4-5/8"	5/8"	3-1/2"	4	5/8"	4	1/2"	5	1/8"	2-1/2
1-1/2"	3592-5/8-IPS	2"	5"	5/8"	3-7/8"	4	5/8"	4	1/2"	5	1/8"	2-3/4
2"	2682-6/8-IPS	2-1/2"	6"	3/4"	4-3/4"	4	3/4"	4	5/8"	6	1/8"	4-1/2
2-1/2"	1822-7/8-IPS	3"	7"	7/8"	5-1/2"	4	3/4"	4	5/8"	7	1/8"	7-1/2
3"	1722-7/8-IPS	3-5/8"	7-1/2"	7/8"	6"	4	3/4"	4	5/8"	7	1/8"	10-1/2
4"	1492-7/8-IPS	4-5/8"	9"	7/8"	7-1/2"	8	3/4"	8	5/8"	7	1/8"	13-1/4
5"	2922-7/8-IPS	5-11/16"	10"	7/8"	8-1/2"	8	7/8"	8	3/4"	7	1/8"	14-1/2
6"	1262-8/8-IPS	6-3/4"	11"	1"	9-1/2"	8	7/8"	8	3/4"	8	1/8"	16-1/2
8"	1442-9/8-IPS	8-3/4"	13-1/2"	1-1/8"	11-3/4"	8	7/8"	8	3/4"	3	3/8"	24-1/2
10"	1502-12/8-IPS	10-7/8"	16"	1-1/2"	14-1/4"	12	1"	12	7/8"	4	3/8"	44-1/2
12"	1522-12/8-IPS	12-7/8"	19"	1-1/2"	17"	12	1"	12	7/8"	4	3/8"	62
14"	1842-12/8-IPS	14-1/2"	21"	1-1/2"	18-3/4"	12	1-1/8"	12	1"	4	3/8"	72
16"	1752-12/8-IPS	16-1/2"	23-1/2"	1-1/2"	21-1/4"	16	1-1/8"	16	1"	4	3/8"	86
18"	1762-12/8-IPS	18-1/2"	25"	1-1/2"	22-3/4"	16	1-1/4"	16	1-1/8"	4	3/8"	91
20"	1772-15/8-IPS	20-1/2"	27-1/2"	1-7/8"	25"	20	1-1/4"	20	1-1/8"	5	3/8"	135
24"	3252-15/8-IPS	24-3/4"	32"	1-7/8"	29-1/2"	20	1-3/8"	20	1-1/4"	5	3/8"	156
30"	3262-18/8-IPS	30-3/4"	38-3/4"	2-1/4"	36"	28	1-3/8"	28	1-1/4"	6	3/8"	250

THE MARZOLF COMPANY

PHONE 715.426.5705 | FAX 715.426.5708
 E-MAIL INFO@MARZOLF.COM
 WWW.MARZOLF.COM

T-316L Stainless Steel — For Types B & C Pipe Stub Ends

T-316L Stainless Steel — For Type A Pipe Stub Ends & Poly Pipe

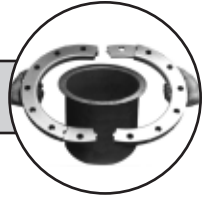

• **Class 75** •

Size	Part No.	Inside Diameter I.D.	Outside Diameter O.D.	Thickness T.	Radius	Bolt Circle B.C.	Holes H.D.		Bolts		Plies		Shipping Weight Lbs.
							No.	Dia.	No.	Size	No.	Ga.	
1/2"	3612-RIPS	7/8"	3-1/2"	3/8"	1/8"	2-3/8"	4	5/8"	4	1/2"	3	1/8"	1
3/4"	3602-RIPS	1-1/8"	3-7/8"	3/8"	1/8"	2-3/4"	4	5/8"	4	1/2"	3	1/8"	1-1/4
1"	3572-RIPS	1-3/8"	4-1/4"	1/2"	1/8"	3-1/8"	4	5/8"	4	1/2"	4	1/8"	1-3/4
1-1/4"	3582-RIPS	1-3/4"	4-5/8"	1/2"	3/16"	3-1/2"	4	5/8"	4	1/2"	4	1/8"	2
1-1/2"	3592-RIPS	2"	5"	1/2"	1/4"	3-7/8"	4	5/8"	4	1/2"	4	1/8"	2-1/4
2"	2682-RIPS	2-1/2"	6"	1/2"	5/16"	4-3/4"	4	3/4"	4	5/8"	4	1/8"	3
2-1/2"	1822-RIPS	3"	7"	1/2"	5/16"	5-1/2"	4	3/4"	4	5/8"	4	1/8"	4
3"	1722-RIPS	3-5/8"	7-1/2"	1/2"	3/8"	6"	4	3/4"	4	5/8"	4	1/8"	4-1/2
4"	1492-RIPS	4-5/8"	9"	1/2"	7/16"	7-1/2"	8	3/4"	8	5/8"	4	1/8"	6
5"	2922-RIPS	5-11/16"	10"	1/2"	7/16"	8-1/2"	8	7/8"	8	3/4"	4	1/8"	6-1/2
6"	1262-RIPS	6-3/4"	11"	1/2"	1/2"	9-1/2"	8	7/8"	8	3/4"	4	1/8"	7-1/2
8"	1442-RIPS	8-3/4"	13-1/2"	1/2"	1/2"	11-3/4"	8	7/8"	8	3/4"	4	1/8"	10-1/2
10"	1502-RIPS	10-7/8"	16"	5/8"	1/2"	14-1/4"	12	1"	12	7/8"	5	1/8"	16-3/4
12"	1522-RIPS	12-7/8"	19"	5/8"	1/2"	17"	12	1"	12	7/8"	5	1/8"	24
14"	1842-RIPS	14-1/2"	21"	7/8"	1/2"	18-3/4"	12	1-1/8"	12	1"	7	1/8"	42
16"	1752-RIPS	16-1/2"	23-1/2"	7/8"	1/2"	21-1/4"	16	1-1/8"	16	1"	7	1/8"	50
18"	1762-RIPS	18-1/2"	25"	7/8"	1/2"	22-3/4"	16	1-1/4"	16	1-1/8"	7	1/8"	53
20"	1772-RIPS	20-1/2"	27-1/2"	7/8"	1/2"	25"	20	1-1/4"	20	1-1/8"	7	1/8"	63
24"	3252-RIPS	24-3/4"	32"	1-1/4"	1/2"	29-1/2"	20	1-3/8"	20	1-1/4"	10	1/8"	104
30"	3262-RIPS	30-3/4"	38-3/4"	1-1/4"	1/2"	36"	28	1-3/8"	28	1-1/4"	10	1/8"	139



PHONE 715.426.5705 | FAX 715.426.5708

E-MAIL INFO@MARZOLF.COM

WWW.MARZOLF.COM

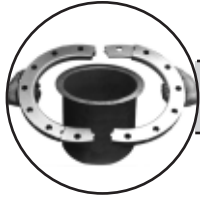

T-316L Stainless Steel — For Type A Pipe Stub Ends & Poly Pipe

• Class 150 •

Size	Part No.	Inside	Outside	Thickness	Radius	Bolt	Holes		Bolts		Plies		Shipping
		Diameter	Diameter				Bolt	No.	Dia.	No.	Size	No.	
		I.D.	O.D.	T.		B.C.	No.	Dia.	No.	Size	No.	Ga.	Lbs.
1/2"	3612-3/8-RIPS	7/8"	3-1/2"	3/8"	1/8"	2-3/8"	4	5/8"	4	1/2"	3	1/8"	1
3/4"	3602-4/8-RIPS	1-1/8"	3-7/8"	1/2"	1/8"	2-3/4"	4	5/8"	4	1/2"	4	1/8"	1-1/2
1"	3572-4/8-RIPS	1-3/8"	4-1/4"	1/2"	1/8"	3-1/8"	4	5/8"	4	1/2"	4	1/8"	1-3/4
1-1/4"	3582-5/8-RIPS	1-3/4"	4-5/8"	5/8"	3/16"	3-1/2"	4	5/8"	4	1/2"	5	1/8"	2-1/2
1-1/2"	3592-5/8-RIPS	2"	5"	5/8"	1/4"	3-7/8"	4	5/8"	4	1/2"	5	1/8"	2-3/4
2"	2682-6/8-RIPS	2-1/2"	6"	3/4"	5/16"	4-3/4"	4	3/4"	4	5/8"	6	1/8"	4-1/2
2-1/2"	1822-7/8-RIPS	3"	7"	7/8"	5/16"	5-1/2"	4	3/4"	4	5/8"	7	1/8"	7-1/2
3"	1722-7/8-RIPS	3-5/8"	7-1/2"	7/8"	3/8"	6"	4	3/4"	4	5/8"	7	1/8"	10-1/2
4"	1492-7/8-RIPS	4-5/8"	9"	7/8"	7/16"	7-1/2"	8	3/4"	8	5/8"	7	1/8"	13-1/4
5"	2922-7/8-RIPS	5-11/16"	10"	7/8"	7/16"	8-1/2"	8	7/8"	8	3/4"	7	1/8"	14-1/2
6"	1262-8/8-RIPS	6-3/4"	11"	1"	1/2"	9-1/2"	8	7/8"	8	3/4"	8	1/8"	16-1/2
8"	1442-9/8-RIPS	8-3/4"	13-1/2"	1-1/8"	1/2"	11-3/4"	8	7/8"	8	3/4"	3	3/8"	24-1/2
10"	1502-12/8-RIPS	10-7/8"	16"	1-1/2"	1/2"	14-1/4"	12	1"	12	7/8"	4	3/8"	44-1/2
12"	1522-12/8-RIPS	12-7/8"	19"	1-1/2"	1/2"	17"	12	1"	12	7/8"	4	3/8"	62
14"	1842-12/8-RIPS	14-1/2"	21"	1-1/2"	1/2"	18-3/4"	12	1-1/8"	12	1"	4	3/8"	72
16"	1752-12/8-RIPS	16-1/2"	23-1/2"	1-1/2"	1/2"	21-1/4"	16	1-1/8"	16	1"	4	3/8"	86
18"	1762-12/8-RIPS	18-1/2"	25"	1-1/2"	1/2"	22-3/4"	16	1-1/4"	16	1-1/8"	4	3/8"	91
20"	1772-15/8-RIPS	20-1/2"	27-1/2"	1-7/8"	1/2"	25"	20	1-1/4"	20	1-1/8"	5	3/8"	135
24"	3252-15/8-RIPS	24-3/4"	32"	1-7/8"	1/2"	29-1/2"	20	1-3/8"	20	1-1/4"	5	3/8"	156
30"	3262-18/8-RIPS	30-3/4"	38-3/4"	2-1/4"	1/2"	36"	28	1-3/8"	28	1-1/4"	6	3/8"	250

T H E
MARZOLF
C O M P A N Y

PHONE 715.426.5705 | FAX 715.426.5708

E-MAIL INFO@MARZOLF.COM

WWW.MARZOLF.COM

T-316L Stainless Steel — For Type A Pipe Stub Ends & Poly Pipe

T-316L Stainless – For Pipe Angle Face Rings

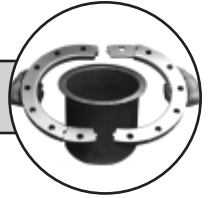

• **Class 75** •

Size	Part No.	Inside Diameter I.D.	Outside Diameter O.D.	Thickness T.	Bolt Circle B.C.	Holes H.D.		Bolts		Plies		Shipping Weight Lbs.
						No.	Dia.	No.	Size	No.	Ga.	
1/2"	3612-PAFR	1-1/8"	3-1/2"	3/8"	2-3/8"	4	5/8"	4	1/2"	3	1/8"	1
3/4"	3602-PAFR	1-3/8"	3-7/8"	3/8"	2-3/4"	4	5/8"	4	1/2"	3	1/8"	1-1/4
1"	3572-PAFR	1-5/8"	4-1/4"	1/2"	3-1/8"	4	5/8"	4	1/2"	4	1/8"	1-3/4
1-1/4"	3582-PAFR	2"	4-5/8"	1/2"	3-1/2"	4	5/8"	4	1/2"	4	1/8"	2
1-1/2"	3592-PAFR	2-1/4"	5"	1/2"	3-7/8"	4	5/8"	4	1/2"	4	1/8"	2-1/4
2"	2682-PAFR	2-3/4"	6"	1/2"	4-3/4"	4	3/4"	4	5/8"	4	1/8"	3
2-1/2"	1822-PAFR	3-1/4"	7"	1/2"	5-1/2"	4	3/4"	4	5/8"	4	1/8"	4
3"	1722-PAFR	3-7/8"	7-1/2"	1/2"	6"	4	3/4"	4	5/8"	4	1/8"	4-1/2
4"	1492-PAFR	4-7/8"	9"	1/2"	7-1/2"	8	3/4"	8	5/8"	4	1/8"	6
5"	2922-PAFR	6-1/16"	10"	1/2"	8-1/2"	8	7/8"	8	3/4"	4	1/8"	6-1/2
6"	1262-PAFR	7-1/8"	11"	1/2"	9-1/2"	8	7/8"	8	3/4"	4	1/8"	7-1/2
8"	1442-PAFR	9-3/16"	13-1/2"	1/2"	11-3/4"	8	7/8"	8	3/4"	4	1/8"	10-1/2
10"	1502-PAFR	11-3/8"	16"	5/8"	14-1/4"	12	1"	12	7/8"	5	1/8"	16-3/4
12"	1522-PAFR	13-1/2"	19"	5/8"	17"	12	1"	12	7/8"	5	1/8"	24
14"	1842-PAFR	14-3/4"	21"	7/8"	18-3/4"	12	1-1/8"	12	1"	7	1/8"	41
16"	1752-PAFR	16-3/4"	23-1/2"	7/8"	21-1/4"	16	1-1/8"	16	1"	7	1/8"	49
18"	1762-PAFR	18-3/4"	25"	7/8"	22-3/4"	16	1-1/4"	16	1-1/8"	7	1/8"	51
20"	1772-PAFR	20-3/4"	27-1/2"	7/8"	25"	20	1-1/4"	20	1-1/8"	7	1/8"	61
24"	3252-PAFR	24-7/8"	32"	1-1/4"	29-1/2"	20	1-3/8"	20	1-1/4"	10	1/8"	102
30"	3262-PAFR	30-7/8"	38-3/4"	1-1/4"	36"	28	1-3/8"	28	1-1/4"	10	1/8"	137

**THE
MARZOLF
COMPANY**

PHONE 715.426.5705 | FAX 715.426.5708

E-MAIL INFO@MARZOLF.COM

WWW.MARZOLF.COM

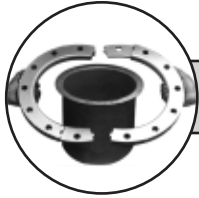

T-316L Stainless – For Pipe Angle Face Rings

• Class 150 •

Size	Part No.	Inside Diameter I.D.	Outside Diameter O.D.	Thickness T.	Bolt Circle B.C.	Holes H.D.		Bolts		Plies		Shipping Weight Lbs.
						No.	Dia.	No.	Size	No.	Ga.	
1/2"	3612-3/8-PAFR	1-1/8"	3-1/2"	3/8"	2-3/8"	4	5/8"	4	1/2"	3	1/8"	1
3/4"	3602-4/8-PAFR	1-3/8"	3-7/8"	1/2"	2-3/4"	4	5/8"	4	1/2"	4	1/8"	1-1/2
1"	3572-4/8-PAFR	1-5/8"	4-1/4"	1/2"	3-1/8"	4	5/8"	4	1/2"	4	1/8"	1-3/4
1-1/4"	3582-5/8-PAFR	2"	4-5/8"	5/8"	3-1/2"	4	5/8"	4	1/2"	5	1/8"	2-1/2
1-1/2"	3592-5/8-PAFR	2-1/4"	5"	5/8"	3-7/8"	4	5/8"	4	1/2"	5	1/8"	2-3/4
2"	2682-6/8-PAFR	2-3/4"	6"	3/4"	4-3/4"	4	3/4"	4	5/8"	6	1/8"	4-1/2
2-1/2"	1822-7/8-PAFR	3-1/4"	7"	7/8"	5-1/2"	4	3/4"	4	5/8"	7	1/8"	7-1/2
3"	1722-7/8-PAFR	3-7/8"	7-1/2"	7/8"	6"	4	3/4"	4	5/8"	7	1/8"	10-1/2
4"	1492-7/8-PAFR	4-7/8"	9"	7/8"	7-1/2"	8	3/4"	8	5/8"	7	1/8"	13-1/4
5"	2922-7/8-PAFR	6-1/16"	10"	7/8"	8-1/2"	8	7/8"	8	3/4"	7	1/8"	14-1/2
6"	1262-8/8-PAFR	7-1/8"	11"	1"	9-1/2"	8	7/8"	8	3/4"	8	1/8"	16-1/2
8"	1442-9/8-PAFR	9-3/16"	13-1/2"	1-1/8"	11-3/4"	8	7/8"	8	3/4"	3	3/8"	24-1/2
10"	1502-12/8-PAFR	11-3/8"	16"	1-1/2"	14-1/4"	12	1"	12	7/8"	4	3/8"	44-1/2
12"	1522-12/8-PAFR	13-1/2"	19"	1-1/2"	17"	12	1"	12	7/8"	4	3/8"	62
14"	1842-12/8-PAFR	14-3/4"	21"	1-1/2"	18-3/4"	12	1-1/8"	12	1"	4	3/8"	72
16"	1752-12/8-PAFR	16-3/4"	23-1/2"	1-1/2"	21-1/4"	16	1-1/8"	16	1"	4	3/8"	86
18"	1762-12/8-PAFR	18-3/4"	25"	1-1/2"	22-3/4"	16	1-1/4"	16	1-1/8"	4	3/8"	91
20"	1772-15/8-PAFR	20-3/4"	27-1/2"	1-7/8"	25"	20	1-1/4"	20	1-1/8"	5	3/8"	135
24"	3252-15/8-PAFR	24-7/8"	32"	1-7/8"	29-1/2"	20	1-3/8"	20	1-1/4"	5	3/8"	156
30"	3262-18/8-PAFR	30-7/8"	38-3/4"	2-1/4"	36"	28	1-3/8"	28	1-1/4"	6	3/8"	250

THE MARZOLF COMPANY

PHONE 715.426.5705 | FAX 715.426.5708

E-MAIL INFO@MARZOLF.COM

WWW.MARZOLF.COM

Zinc Plated Carbon Steel — For OD Tube Stub Ends

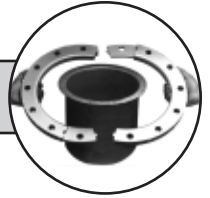

• Class 75 •

Size	Part No.	Inside Diameter I.D.	Outside Diameter O.D.	Thickness T.	Bolt Circle B.C.	Holes H.D.		Bolts		Plies		Shipping Weight Lbs.
						No.	Dia.	No.	Size	No.	Ga.	
3/4"	361-STD	7/8"	3-1/2"	9/16"	2-3/8"	4	5/8"	4	1/2"	3	3/16"	1-1/4
1"	360-STD	1-1/8"	3-7/8"	9/16"	2-3/4"	4	5/8"	4	1/2"	3	3/16"	1-1/2
1-1/4"	357-STD	1-3/8"	4-1/4"	9/16"	3-1/8"	4	5/8"	4	1/2"	3	3/16"	1-3/4
1-1/2"	358-STD	1-3/4"	4-5/8"	9/16"	3-1/2"	4	5/8"	4	1/2"	3	3/16"	2
1-3/4"	359-STD	2"	5"	9/16"	3-7/8"	4	5/8"	4	1/2"	3	3/16"	2-1/3
2"	268-STD	2-3/8"	6"	9/16"	4-3/4"	4	3/4"	4	5/8"	3	3/16"	3-1/2
2-1/2"	182-STD	2-7/8"	7"	9/16"	5-1/2"	4	3/4"	4	5/8"	3	3/16"	5
3"	172-STD	3-3/8"	7-1/2"	9/16"	6"	4	3/4"	4	5/8"	3	3/16"	6
4"	149-STD	4-3/8"	9"	9/16"	7-1/2"	8	3/4"	8	5/8"	3	3/16"	6-3/4
5"	292-STD	5-3/8"	10"	9/16"	8-1/2"	8	7/8"	8	3/4"	3	3/16"	7-1/2
6"	126-STD	6-3/8"	11"	9/16"	9-1/2"	8	7/8"	8	3/4"	3	3/16"	9-1/4
8"	144-STD	8-3/8"	13-1/2"	9/16"	11-3/4"	8	7/8"	8	3/4"	3	3/16"	14
10"	150-STD	10-3/8"	16"	3/4"	14-1/4"	12	1"	12	7/8"	4	3/16"	23
12"	152-STD	12-3/8"	19"	3/4"	17"	12	1"	12	7/8"	4	3/16"	33
14"	184-STD	14-1/2"	21"	15/16"	18-3/4"	12	1-1/8"	12	1"	5	3/16"	45
16"	175-STD	16-1/2"	23-1/2"	15/16"	21-1/4"	16	1-1/8"	16	1"	5	3/16"	53
18"	176-STD	18-1/2"	25"	15/16"	22-3/4"	16	1-1/4"	16	1-1/8"	5	3/16"	55
20"	177-STD	20-1/2"	27-1/2"	15/16"	25"	20	1-1/4"	20	1-1/8"	5	3/16"	66
24"	325-STD	24-3/4"	32"	1-5/16"	29-1/2"	20	1-3/8"	20	1-1/4"	7	3/16"	108
30"	326-STD	30-3/4"	38-3/4"	1-5/16"	36"	28	1-3/8"	28	1-1/4"	7	3/16"	145



PHONE 715.426.5705 | FAX 715.426.5708

E-MAIL INFO@MARZOLF.COM

WWW.MARZOLF.COM

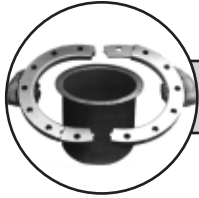

Zinc Plated Carbon Steel — For OD Tube Stub Ends

• Class 150 •

Size	Part No.	Inside Diameter I.D.	Outside Diameter O.D.	Thickness T.	Bolt Circle B.C.	Holes H.D.		Bolts		Plies		Shipping Weight Lbs.
						No.	Dia.	No.	Size	No.	Ga.	
3/4"	361-9/16-STD	7/8"	3-1/2"	9/16"	2-3/8"	4	5/8"	4	1/2"	3	3/16"	1-1/4
1"	360-9/16-STD	1-1/8"	3-7/8"	9/16"	2-3/4"	4	5/8"	4	1/2"	3	3/16"	1-1/2
1-1/4"	357-9/16-STD	1-3/8"	4-1/4"	9/16"	3-1/8"	4	5/8"	4	1/2"	3	3/16"	1-3/4
1-1/2"	358-12/16-STD	1-3/4"	4-5/8"	3/4"	3-1/2"	4	5/8"	4	1/2"	4	3/16"	2-1/2
1-3/4"	359-12/16-STD	2"	5"	3/4"	3-7/8"	4	5/8"	4	1/2"	4	3/16"	3-1/4
2"	268-12/16-STD	2-3/8"	6"	3/4"	4-3/4"	4	3/4"	4	5/8"	4	3/16"	4-1/2
2-1/2"	182-15/16-STD	2-7/8"	7"	15/16"	5-1/2"	4	3/4"	4	5/8"	5	3/16"	8-1/4
3"	172-15/16-STD	3-3/8"	7-1/2"	15/16"	6"	4	3/4"	4	5/8"	5	3/16"	10
4"	149-15/16-STD	4-3/8"	9"	15/16"	7-1/2"	8	3/4"	8	5/8"	5	3/16"	11-1/4
5"	292-15/16-STD	5-3/8"	10"	15/16"	8-1/2"	8	7/8"	8	3/4"	5	3/16"	12-1/2
6"	126-15/16-STD	6-3/8"	11"	15/16"	9-1/2"	8	7/8"	8	3/4"	5	3/16"	18-1/2
8"	144-9/8-STD	8-3/8"	13-1/2"	1-1/8"	11-3/4"	8	7/8"	8	3/4"	3	3/8"	28
10"	150-12/8-STD	10-3/8"	16"	1-1/2"	14-1/4"	12	1"	12	7/8"	4	3/8"	46
12"	152-12/8-STD	12-3/8"	19"	1-1/2"	17"	12	1"	12	7/8"	4	3/8"	66
14"	184-12/8-STD	14-1/2"	21"	1-1/2"	18-3/4"	12	1-1/8"	12	1"	4	3/8"	72
16"	175-12/8-STD	16-1/2"	23-1/2"	1-1/2"	21-1/4"	16	1-1/8"	16	1"	4	3/8"	85
18"	176-12/8-STD	18-1/2"	25"	1-1/2"	22-3/4"	16	1-1/4"	16	1-1/8"	4	3/8"	88
20"	177-15/8-STD	20-1/2"	27-1/2"	1-7/8"	25"	20	1-1/4"	20	1-1/8"	5	3/8"	132
24"	325-15/8-STD	24-3/4"	32"	1-7/8"	29-1/2"	20	1-3/8"	20	1-1/4"	5	3/8"	154
30"	326-18/8-STD	30-3/4"	38-3/4"	2-1/4"	36"	28	1-3/8"	28	1-1/4"	6	3/8"	249

THE MARZOLF COMPANY

PHONE 715.426.5705 | FAX 715.426.5708
 E-MAIL INFO@MARZOLF.COM
 WWW.MARZOLF.COM

Zinc Plated Carbon Steel — For OD Tube Angle Face Rings

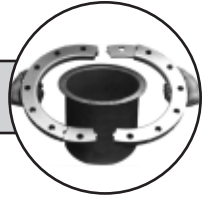

• Class 75 •

Size	Part No.	Inside Diameter I.D.	Outside Diameter O.D.	Thickness T.	Bolt Circle B.C.	Holes H.D.		Bolts		Plies		Shipping Weight Lbs.
						No.	Dia.	No.	Size	No.	Ga.	
3/4"	361-TAFR	7/8"	3-1/2"	9/16"	2-3/8"	4	5/8"	4	1/2"	3	3/16"	1-1/4
1"	360-TAFR	1-1/8"	3-7/8"	9/16"	2-3/4"	4	5/8"	4	1/2"	3	3/16"	1-1/2
1-1/4"	357-TAFR	1-3/8"	4-1/4"	9/16"	3-1/8"	4	5/8"	4	1/2"	3	3/16"	1-3/4
1-1/2"	358-TAFR	1-3/4"	4-5/8"	9/16"	3-1/2"	4	5/8"	4	1/2"	3	3/16"	2
1-3/4"	359-TAFR	2"	5"	9/16"	3-7/8"	4	5/8"	4	1/2"	3	3/16"	2-1/3
2"	268-TAFR	2-1/2"	6"	9/16"	4-3/4"	4	3/4"	4	5/8"	3	3/16"	3-1/2
2-1/2"	182-TAFR	3"	7"	9/16"	5-1/2"	4	3/4"	4	5/8"	3	3/16"	5
3"	172-TAFR	3-5/8"	7-1/2"	9/16"	6"	4	3/4"	4	5/8"	3	3/16"	6
4"	149-TAFR	4-5/8"	9"	9/16"	7-1/2"	8	3/4"	8	5/8"	3	3/16"	6-3/4
5"	292-TAFR	5-11/16"	10"	9/16"	8-1/2"	8	7/8"	8	3/4"	3	3/16"	7-1/2
6"	126-TAFR	6-3/4"	11"	9/16"	9-1/2"	8	7/8"	8	3/4"	3	3/16"	9-1/4
8"	144-TAFR	8-3/4"	13-1/2"	9/16"	11-3/4"	8	7/8"	8	3/4"	3	3/16"	14
10"	150-TAFR	10-7/8"	16"	3/4"	14-1/4"	12	1"	12	7/8"	4	3/16"	22
12"	152-TAFR	12-7/8"	19"	3/4"	17"	12	1"	12	7/8"	4	3/16"	31-1/2
14"	184-TAFR	14-3/4"	21"	15/16"	18-3/4"	12	1-1/8"	12	1"	5	3/16"	45
16"	175-TAFR	16-3/4"	23-1/2"	15/16"	21-1/4"	16	1-1/8"	16	1"	5	3/16"	53
18"	176-TAFR	18-3/4"	25"	15/16"	22-3/4"	16	1-1/4"	16	1-1/8"	5	3/16"	55
20"	177-TAFR	20-3/4"	27-1/2"	15/16"	25"	20	1-1/4"	20	1-1/8"	5	3/16"	66
24"	325-TAFR	24-7/8"	32"	1-5/16"	29-1/2"	20	1-3/8"	20	1-1/4"	7	3/16"	108
30"	326-TAFR	30-7/8"	38-3/4"	1-5/16"	36"	28	1-3/8"	28	1-1/4"	7	3/16"	145



PHONE 715.426.5705 | FAX 715.426.5708
 E-MAIL INFO@MARZOLF.COM
 WWW.MARZOLF.COM

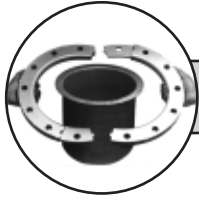

Zinc Plated Carbon Steel — For OD Tube Angle Face Rings

• Class 150 •

Size	Part No.	Inside Diameter I.D.	Outside Diameter O.D.	Thickness T.	Bolt Circle B.C.	Holes H.D.		Bolts		Plies		Shipping Weight Lbs.
						No.	Dia.	No.	Size	No.	Ga.	
3/4"	361-9/16-TAFR	7/8"	3-1/2"	9/16"	2-3/8"	4	5/8"	4	1/2"	3	3/16"	1-1/4
1"	360-9/16-TAFR	1-1/8"	3-7/8"	9/16"	2-3/4"	4	5/8"	4	1/2"	3	3/16"	1-1/2
1-1/4"	357-9/16-TAFR	1-3/8"	4-1/4"	9/16"	3-1/8"	4	5/8"	4	1/2"	3	3/16"	1-3/4
1-1/2"	358-12/16-TAFR	1-3/4"	4-5/8"	3/4"	3-1/2"	4	5/8"	4	1/2"	4	3/16"	2-1/2
1-3/4"	359-12/16-TAFR	2"	5"	3/4"	3-7/8"	4	5/8"	4	1/2"	4	3/16"	3-1/4
2"	268-12/16-TAFR	2-1/2"	6"	3/4"	4-3/4"	4	3/4"	4	5/8"	4	3/16"	4-1/2
2-1/2"	182-15/16-TAFR	3"	7"	15/16"	5-1/2"	4	3/4"	4	5/8"	5	3/16"	8-1/4
3"	172-15/16-TAFR	3-5/8"	7-1/2"	15/16"	6"	4	3/4"	4	5/8"	5	3/16"	10
4"	149-15/16-TAFR	4-5/8"	9"	15/16"	7-1/2"	8	3/4"	8	5/8"	5	3/16"	11-1/4
5"	292-15/16-TAFR	5-11/16"	10"	15/16"	8-1/2"	8	7/8"	8	3/4"	5	3/16"	12-1/2
6"	126-15/16-TAFR	6-3/4"	11"	15/16"	9-1/2"	8	7/8"	8	3/4"	5	3/16"	18-1/2
8"	144-9/8-TAFR	8-3/4"	13-1/2"	1-1/8"	11-3/4"	8	7/8"	8	3/4"	3	3/8"	28
10"	150-12/8-TAFR	10-7/8"	16"	1-1/2"	14-1/4"	12	1"	12	7/8"	4	3/8"	46
12"	152-12/8-TAFR	12-7/8"	19"	1-1/2"	17"	12	1"	12	7/8"	4	3/8"	66
14"	184-12/8-TAFR	14-3/4"	21"	1-1/2"	18-3/4"	12	1-1/8"	12	1"	4	3/8"	72
16"	175-12/8-TAFR	16-3/4"	23-1/2"	1-1/2"	21-1/4"	16	1-1/8"	16	1"	4	3/8"	85
18"	176-12/8-TAFR	18-3/4"	25"	1-1/2"	22-3/4"	16	1-1/4"	16	1-1/8"	4	3/8"	88
20"	177-15/8-TAFR	20-3/4"	27-1/2"	1-7/8"	25"	20	1-1/4"	20	1-1/8"	5	3/8"	132
24"	325-15/8-TAFR	24-7/8"	32"	1-7/8"	29-1/2"	20	1-3/8"	20	1-1/4"	5	3/8"	154
30"	326-18/8-TAFR	30-7/8"	38-3/4"	2-1/4"	36"	28	1-3/8"	28	1-1/4"	6	3/8"	249

THE MARZOLF COMPANY

PHONE 715.426.5705 | FAX 715.426.5708
 E-MAIL INFO@MARZOLF.COM
 WWW.MARZOLF.COM

Zinc Plated Carbon Steel — For OD Tube Angle Face Rings

Zinc Plated Carbon Steel — For Types B & C Pipe Stub Ends

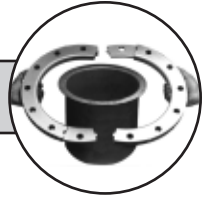

• **Class 75** •

Size	Part No.	Inside Diameter I.D.	Outside Diameter O.D.	Thickness T.	Bolt Circle B.C.	Holes H.D.		Bolts		Plies		Shipping Weight Lbs.
						No.	Dia.	No.	Size	No.	Ga.	
1/2	361-IPS	7/8"	3-1/2"	9/16"	2-3/8"	4	5/8"	4	1/2"	3	3/16"	1-1/4
3/4"	360-IPS	1-1/8"	3-7/8"	9/16"	2-3/4"	4	5/8"	4	1/2"	3	3/16"	1-1/2
1"	357-IPS	1-3/8"	4-1/4"	9/16"	3-1/8"	4	5/8"	4	1/2"	3	3/16"	1-3/4
1-1/4"	358-IPS	1-3/4"	4-5/8"	9/16"	3-1/2"	4	5/8"	4	1/2"	3	3/16"	2
1-1/2"	359-IPS	2"	5"	9/16"	3-7/8"	4	5/8"	4	1/2"	3	3/16"	2-1/3
2"	268-IPS	2-1/2"	6"	9/16"	4-3/4"	4	3/4"	4	5/8"	3	3/16"	3-1/2
2-1/2"	182-IPS	3"	7"	9/16"	5-1/2"	4	3/4"	4	5/8"	3	3/16"	5
3"	172-IPS	3-5/8"	7-1/2"	9/16"	6"	4	3/4"	4	5/8"	3	3/16"	6
4"	149-IPS	4-5/8"	9"	9/16"	7-1/2"	8	3/4"	8	5/8"	3	3/16"	6-3/4
5"	292-IPS	5-11/16"	10"	9/16"	8-1/2"	8	7/8"	8	3/4"	3	3/16"	7-1/2
6"	126-IPS	6-3/4"	11"	9/16"	9-1/2"	8	7/8"	8	3/4"	3	3/16"	9-1/4
8"	144-IPS	8-3/4"	13-1/2"	9/16"	11-3/4"	8	7/8"	8	3/4"	3	3/16"	14
10"	150-IPS	10-7/8"	16"	3/4"	14-1/4"	12	1"	12	7/8"	4	3/16"	23
12"	152-IPS	12-7/8"	19"	3/4"	17"	12	1"	12	7/8"	4	3/16"	31-1/2
14"	184-IPS	14-1/2"	21"	15/16"	18-3/4"	12	1-1/8"	12	1"	5	3/16"	45
16"	175-IPS	16-1/2"	23-1/2"	15/16"	21-1/4"	16	1-1/8"	16	1"	5	3/16"	53
18"	176-IPS	18-1/2"	25"	15/16"	22-3/4"	16	1-1/4"	16	1-1/8"	5	3/16"	55
20"	177-IPS	20-1/2"	27-1/2"	15/16"	25"	20	1-1/4"	20	1-1/8"	5	3/16"	66
24"	325-IPS	24-3/4"	32"	1-5/16"	29-1/2"	20	1-3/8"	20	1-1/4"	7	3/16"	108
30"	326-IPS	30-3/4"	38-3/4"	1-5/16"	36"	28	1-3/8"	28	1-1/4"	7	3/16"	145

**THE
MARZOLF
COMPANY**

PHONE 715.426.5705 | FAX 715.426.5708

E-MAIL INFO@MARZOLF.COM

WWW.MARZOLF.COM

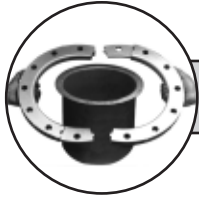

Zinc Plated Carbon Steel — For Types B & C Pipe Stub Ends

• Class 150 •

Size	Part No.	Inside Diameter I.D.	Outside Diameter O.D.	Thickness T.	Bolt Circle B.C.	Holes H.D.		Bolts		Plies		Shipping Weight Lbs.
						No.	Dia.	No.	Size	No.	Ga.	
1/2"	361-9/16-IPS	7/8"	3-1/2"	9/16"	2-3/8"	4	5/8"	4	1/2"	3	3/16"	1-1/4
3/4"	360-9/16-IPS	1-1/8"	3-7/8"	9/16"	2-3/4"	4	5/8"	4	1/2"	3	3/16"	1-1/2
1"	357-9/16-IPS	1-3/8"	4-1/4"	9/16"	3-1/8"	4	5/8"	4	1/2"	3	3/16"	1-3/4
1-1/4"	358-12/16-IPS	1-3/4"	4-5/8"	3/4"	3-1/2"	4	5/8"	4	1/2"	4	3/16"	2-1/2
1-1/2"	359-12/16-IPS	2"	5"	3/4"	3-7/8"	4	5/8"	4	1/2"	4	3/16"	3-1/4
2"	268-12/16-IPS	2-1/2"	6"	3/4"	4-3/4"	4	3/4"	4	5/8"	4	3/16"	4-1/2
2-1/2"	182-15/16-IPS	3"	7"	15/16"	5-1/2"	4	3/4"	4	5/8"	5	3/16"	8-1/4
3"	172-15/16-IPS	3-5/8"	7-1/2"	15/16"	6"	4	3/4"	4	5/8"	5	3/16"	10
4"	149-15/16-IPS	4-5/8"	9"	15/16"	7-1/2"	8	3/4"	8	5/8"	5	3/16"	11-1/4
5"	292-15/16-IPS	5-11/16"	10"	15/16"	8-1/2"	8	7/8"	8	3/4"	5	3/16"	12-1/2
6"	126-15/16-IPS	6-3/4"	11"	15/16"	9-1/2"	8	7/8"	8	3/4"	5	3/16"	18-1/2
8"	144-9/8-IPS	8-3/4"	13-1/2"	1-1/8"	11-3/4"	8	7/8"	8	3/4"	3	3/8"	28
10"	150-12/8-IPS	10-7/8"	16"	1-1/2"	14-1/4"	12	1"	12	7/8"	4	3/8"	46
12"	152-12/8-IPS	12-7/8"	19"	1-1/2"	17"	12	1"	12	7/8"	4	3/8"	66
14"	184-12/8-IPS	14-1/2"	21"	1-1/2"	18-3/4"	12	1-1/8"	12	1"	4	3/8"	72
16"	175-12/8-IPS	16-1/2"	23-1/2"	1-1/2"	21-1/4"	16	1-1/8"	16	1"	4	3/8"	85
18"	176-12/8-IPS	18-1/2"	25"	1-1/2"	22-3/4"	16	1-1/4"	16	1-1/8"	4	3/8"	88
20"	177-15/8-IPS	20-1/2"	27-1/2"	1-7/8"	25"	20	1-1/4"	20	1-1/8"	5	3/8"	132
24"	325-15/8-IPS	24-3/4"	32"	1-7/8"	29-1/2"	20	1-3/8"	20	1-1/4"	5	3/8"	154
30"	326-18/8-IPS	30-3/4"	38-3/4"	2-1/4"	36"	28	1-3/8"	28	1-1/4"	6	3/8"	249

THE MARZOLF COMPANY

PHONE 715.426.5705 | FAX 715.426.5708

E-MAIL INFO@MARZOLF.COM

WWW.MARZOLF.COM

Zinc Plated Carbon Steel — For Types B & C Pipe Stub Ends

Zinc Plated Carbon Steel – Type A Pipe Stub Ends & Poly Pipe

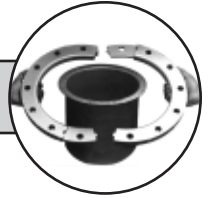

• **Class 75** •

Size	Part No.	Inside Diameter I.D.	Outside Diameter O.D.	Thickness T.	Radius	Bolt Circle B.C.	Holes H.D.		Bolts		Plies		Shipping Weight Lbs.
							No.	Dia.	No.	Size	No.	Ga.	
1/2"	361-RIPS	7/8"	3-1/2"	9/16"	1/8"	2-3/8"	4	5/8"	4	1/2"	3	3/16"	1-1/4
3/4"	360-RIPS	1-1/8"	3-7/8"	9/16"	1/8"	2-3/4"	4	5/8"	4	1/2"	3	3/16"	1-1/2
1"	357-RIPS	1-3/8"	4-1/4"	9/16"	1/8"	3-1/8"	4	5/8"	4	1/2"	3	3/16"	1-3/4
1-1/4"	358-RIPS	1-3/4"	4-5/8"	9/16"	3/16"	3-1/2"	4	5/8"	4	1/2"	3	3/16"	2
1-1/2"	359-RIPS	2"	5"	9/16"	1/4"	3-7/8"	4	5/8"	4	1/2"	3	3/16"	2-1/3
2"	268-RIPS	2-1/2"	6"	9/16"	5/16"	4-3/4"	4	3/4"	4	5/8"	3	3/16"	3-1/2
2-1/2"	182-RIPS	3"	7"	9/16"	5/16"	5-1/2"	4	3/4"	4	5/8"	3	3/16"	5
3"	172-RIPS	3-5/8"	7-1/2"	9/16"	3/8"	6"	4	3/4"	4	5/8"	3	3/16"	6
4"	149-RIPS	4-5/8"	9"	9/16"	7/16"	7-1/2"	8	3/4"	8	5/8"	3	3/16"	6-3/4
5"	292-RIPS	5-11/16"	10"	9/16"	7/16"	8-1/2"	8	7/8"	8	3/4"	3	3/16"	7-1/2
6"	126-RIPS	6-3/4"	11"	9/16"	1/2"	9-1/2"	8	7/8"	8	3/4"	3	3/16"	9-1/4
8"	144-RIPS	8-3/4"	13-1/2"	9/16"	1/2"	11-3/4"	8	7/8"	8	3/4"	3	3/16"	14
10"	150-RIPS	10-7/8"	16"	3/4"	1/2"	14-1/4"	12	1"	12	7/8"	4	3/16"	22
12"	152-RIPS	12-7/8"	19"	3/4"	1/2"	17"	12	1"	12	7/8"	4	3/16"	31-1/2
14"	184-RIPS	14-1/2"	21"	15/16"	1/2"	18-3/4"	12	1-1/8"	12	1"	5	3/16"	45
16"	175-RIPS	16-1/2"	23-1/2"	15/16"	1/2"	21-1/4"	16	1-1/8"	16	1"	5	3/16"	53
18"	176-RIPS	18-1/2"	25"	15/16"	1/2"	22-3/4"	16	1-1/4"	16	1-1/8"	5	3/16"	55
20"	177-RIPS	20-1/2"	27-1/2"	15/16"	1/2"	25"	20	1-1/4"	20	1-1/8"	5	3/16"	66
24"	325-RIPS	24-3/4"	32"	1-5/16"	1/2"	29-1/2"	20	1-3/8"	20	1-1/4"	7	3/16"	108
30"	326-RIPS	30-3/4"	38-3/4"	1-5/16"	1/2"	36"	28	1-3/8"	28	1-1/4"	7	3/16"	145

**THE
MARZOLF
COMPANY**

PHONE 715.426.5705 | FAX 715.426.5708
E-MAIL INFO@MARZOLF.COM
WWW.MARZOLF.COM

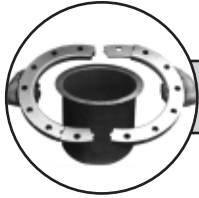

Zinc Plated Carbon Steel – Type A Pipe Stub Ends & Poly Pipe

• Class 150 •

Size	Part No.	Inside	Outside	Thickness	Radius	Bolt	Holes		Bolts		Plies		Shipping
		Diameter	Diameter				No.	Dia.	No.	Size	No.	Ga.	
I.D.	O.D.	T.	B.C.	Lbs.									
1/2"	361-9/16-RIPS	7/8"	3-1/2"	9/16"	1/8"	2-3/8"	4	5/8"	4	1/2"	3	3/16"	1-1/4
3/4"	360-9/16-RIPS	1-1/8"	3-7/8"	9/16"	1/8"	2-3/4"	4	5/8"	4	1/2"	3	3/16"	1-1/2
1"	357-9/16-RIPS	1-3/8"	4-1/4"	9/16"	1/8"	3-1/8"	4	5/8"	4	1/2"	3	3/16"	1-3/4
1-1/4"	358-12/16-RIPS	1-3/4"	4-5/8"	3/4"	3/16"	3-1/2"	4	5/8"	4	1/2"	4	3/16"	2-1/2
1-1/2"	359-12/16-RIPS	2"	5"	3/4"	1/4"	3-7/8"	4	5/8"	4	1/2"	4	3/16"	3-1/4
2"	268-12/16-RIPS	2-1/2"	6"	3/4"	5/16"	4-3/4"	4	3/4"	4	5/8"	4	3/16"	4-1/2
2-1/2"	182-15/16-RIPS	3"	7"	15/16"	5/16"	5-1/2"	4	3/4"	4	5/8"	5	3/16"	8-1/4
3"	172-15/16-RIPS	3-5/8"	7-1/2"	15/16"	3/8"	6"	4	3/4"	4	5/8"	5	3/16"	10
4"	149-15/16-RIPS	4-5/8"	9"	15/16"	7/16"	7-1/2"	8	3/4"	8	5/8"	5	3/16"	11-1/4
5"	292-15/16-RIPS	5-11/16"	10"	15/16"	7/16"	8-1/2"	8	7/8"	8	3/4"	5	3/16"	12-1/2
6"	126-15/16-RIPS	6-3/4"	11"	15/16"	1/2"	9-1/2"	8	7/8"	8	3/4"	5	3/16"	18-1/2
8"	144-9/8-RIPS	8-3/4"	13-1/2"	1-1/8"	1/2"	11-3/4"	8	7/8"	8	3/4"	3	3/8"	28
10"	150-12/8-RIPS	10-7/8"	16"	1-1/2"	1/2"	14-1/4"	12	1"	12	7/8"	4	3/8"	46
12"	152-12/8-RIPS	12-7/8"	19"	1-1/2"	1/2"	17"	12	1"	12	7/8"	4	3/8"	66
14"	184-12/8-RIPS	14-1/2"	21"	1-1/2"	1/2"	18-3/4"	12	1-1/8"	12	1"	4	3/8"	72
16"	175-12/8-RIPS	16-1/2"	23-1/2"	1-1/2"	1/2"	21-1/4"	16	1-1/8"	16	1"	4	3/8"	85
18"	176-12/8-RIPS	18-1/2"	25"	1-1/2"	1/2"	22-3/4"	16	1-1/4"	16	1-1/8"	4	3/8"	88
20"	177-15/8-RIPS	20-1/2"	27-1/2"	1-7/8"	1/2"	25"	20	1-1/4"	20	1-1/8"	5	3/8"	132
24"	325-15/8-RIPS	24-3/4"	32"	1-7/8"	1/2"	29-1/2"	20	1-3/8"	20	1-1/4"	5	3/8"	154
30"	326-18/8-RIPS	30-3/4"	38-3/4"	2-1/4"	1/2"	36"	28	1-3/8"	28	1-1/4"	6	3/8"	249

THE
MARZOLF
COMPANY

PHONE 715.426.5705 | FAX 715.426.5708

E-MAIL INFO@MARZOLF.COM

WWW.MARZOLF.COM

Zinc Plated Carbon Steel – Type A Pipe Stub Ends & Poly Pipe

Zinc Plated Carbon Steel — For Pipe Angle Face Rings

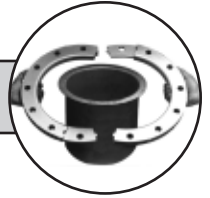

• Class 75 •

Size	Part No.	Inside Diameter I.D.	Outside Diameter O.D.	Thickness T.	Bolt Circle B.C.	Holes H.D.		Bolts		Plies		Shipping Weight Lbs.
						No.	Dia.	No.	Size	No.	Ga.	
1/2"	361-PAFR	1-1/8"	3-1/2"	9/16"	2-3/8"	4	5/8"	4	1/2"	3	3/16"	1-1/4
3/4"	360-PAFR	1-3/8"	3-7/8"	9/16"	2-3/4"	4	5/8"	4	1/2"	3	3/16"	1-1/2
1"	357-PAFR	1-5/8"	4-1/4"	9/16"	3-1/8"	4	5/8"	4	1/2"	3	3/16"	1-3/4
1-1/4"	358-PAFR	2"	4-5/8"	9/16"	3-1/2"	4	5/8"	4	1/2"	3	3/16"	2
1-1/2"	359-PAFR	2-1/4"	5"	9/16"	3-7/8"	4	5/8"	4	1/2"	3	3/16"	2-1/3
2"	268-PAFR	2-3/4"	6"	9/16"	4-3/4"	4	3/4"	4	5/8"	3	3/16"	3-1/2
2-1/2"	182-PAFR	3-1/4"	7"	9/16"	5-1/2"	4	3/4"	4	5/8"	3	3/16"	5
3"	172-PAFR	3-7/8"	7-1/2"	9/16"	6"	4	3/4"	4	5/8"	3	3/16"	6
4"	149-PAFR	4-7/8"	9"	9/16"	7-1/2"	8	3/4"	8	5/8"	3	3/16"	6-3/4
5"	292-PAFR	6-1/16"	10"	9/16"	8-1/2"	8	7/8"	8	3/4"	3	3/16"	7-1/2
6"	126-PAFR	7-1/8"	11"	9/16"	9-1/2"	8	7/8"	8	3/4"	3	3/16"	9-1/4
8"	144-PAFR	9-3/16"	13-1/2"	9/16"	11-3/4"	8	7/8"	8	3/4"	3	3/16"	14
10"	150-PAFR	11-3/8"	16"	3/4"	14-1/4"	12	1"	12	7/8"	4	3/16"	21
12"	152-PAFR	13-1/2"	19"	3/4"	17"	12	1"	12	7/8"	4	3/16"	30
14"	184-PAFR	14-3/4"	21"	15/16"	18-3/4"	12	1-1/8"	12	1"	5	3/16"	45
16"	175-PAFR	16-3/4"	23-1/2"	15/16"	21-1/4"	16	1-1/8"	16	1"	5	3/16"	53
18"	176-PAFR	18-3/4"	25"	15/16"	22-3/4"	16	1-1/4"	16	1-1/8"	5	3/16"	55
20"	177-PAFR	20-3/4"	27-1/2"	15/16"	25"	20	1-1/4"	20	1-1/8"	5	3/16"	66
24"	325-PAFR	24-7/8"	32"	1-5/16"	29-1/2"	20	1-3/8"	20	1-1/4"	7	3/16"	108
30"	326-PAFR	30-7/8"	38-3/4"	1-5/16"	36"	28	1-3/8"	28	1-1/4"	7	3/16"	145



PHONE 715.426.5705 | FAX 715.426.5708

E-MAIL INFO@MARZOLF.COM

WWW.MARZOLF.COM

Zinc Plated Carbon Steel – For Smith Fibercast Molded Flanges

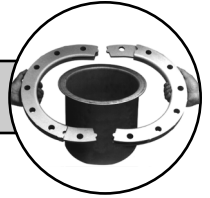

• **Class 150** •

Size	Part No.	Inside Diameter I.D.	Outside Diameter O.D.	Thickness T.	Radius	Bolt Circle B.C.	Holes		Plies		Shipping Weight Lbs.
							No.	Dia.	No.	Ga.	
1"	357-SFP	2.07"	4-1/4"	9/16"	1/4"	3-1/8"	4	5/8"	3	3/16"	1
1-1/2"	359-SFP	2.94"	5"	9/16"	1/4"	3-7/8"	4	5/8"	3	3/16"	2
2"	268-SFP	3.46"	6"	9/16"	1/4"	4-3/4"	4	3/4"	3	3/16"	3
2-1/2"	182-SFP	TBD	7"	9/16"	1/4"	5-1/2"	4	3/4"	3	3/16"	4
3"	172-SFP	4.65"	7-1/2"	9/16"	1/4"	6"	4	3/4"	3	3/16"	5
4"	149-SFP	5.84"	9"	9/16"	3/8"	7-1/2"	8	3/4"	3	3/16"	6
6"	126-SFP	7.82"	11"	9/16"	3/8"	9-1/2"	8	7/8"	3	3/16"	8
8"	144-SFP	10.15"	13-1/2"	9/16"	3/8"	11-3/4"	8	7/8"	3	3/16"	12
10"	150-SFP	12.55"	16"	9/16"	3/8"	14-1/4"	12	1"	3	3/16"	15
12"	152-SFP	14.71"	19"	9/16"	3/8"	17"	12	1"	3	3/16"	23
14"	184-SFP	TBD	21"	9/16"	3/8"	18-3/4"	12	1-1/8"	3	3/16"	26

**THE
MARZOLF
COMPANY**

PHONE 715.426.5705 | FAX 715.426.5708

E-MAIL INFO@MARZOLF.COM

WWW.MARZOLF.COM



T-316L Stainless Steel – For Smith Fibercast Molded Flanges

• Class 150 •

Size	Part No.	Inside Diameter I.D.	Outside Diameter O.D.	Thickness T.	Radius	Bolt Circle B.C.	Holes H.D.		Plies		Shipping Weight Lbs.
							No.	Dia.	No.	Ga.	
1"	3572-SFP	2.07"	4-1/4"	1/2"	1/4"	3-1/8"	4	5/8"	4	1/8"	1
1-1/2"	3592-SFP	2.94"	5"	1/2"	1/4"	3-7/8"	4	5/8"	4	1/8"	2
2"	2682-SFP	3.46"	6"	1/2"	1/4"	4-3/4"	4	3/4"	4	1/8"	3
2-1/2"	1822-SFP	TBD	7"	1/2"	1/4"	5-1/2"	4	3/4"	4	1/8"	4
3"	1722-SFP	4.65"	7-1/2"	1/2"	1/4"	6"	4	3/4"	4	1/8"	5
4"	1492-SFP	5.84"	9"	1/2"	3/8"	7-1/2"	8	3/4"	4	1/8"	6
6"	1262-SFP	7.82"	11"	1/2"	3/8"	9-1/2"	8	7/8"	4	1/8"	8
8"	1442-SFP	10.15"	13-1/2"	1/2"	3/8"	11-3/4"	8	7/8"	4	1/8"	12
10"	1502-SFP	12.55"	16"	1/2"	3/8"	14-1/4"	12	1"	4	1/8"	15
12"	1522-SFP	14.71"	19"	1/2"	3/8"	17"	12	1"	4	1/8"	23
14"	1842-SFP	TBD	21"	1/2"	3/8"	18-3/4"	12	1-1/8"	4	1/8"	26

THE
MARZOLF
COMPANY

PHONE 715.426.5705 | FAX 715.426.5708

E-MAIL INFO@MARZOLF.COM

WWW.MARZOLF.COM

T-316L S.S. Backing Rings for Smith Fibercast Molded Flanges

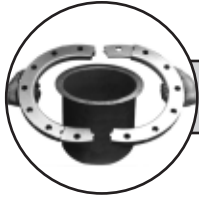

Zinc Plated Carbon Steel — For Pipe Angle Face Rings

• Class 150 •

Size	Part No.	Inside Diameter I.D.	Outside Diameter O.D.	Thickness T.	Bolt Circle B.C.	Holes H.D.		Bolts		Plies		Shipping Weight Lbs.
						No.	Dia.	No.	Size	No.	Ga.	
1/2"	361-9/16-PAFR	1-1/8"	3-1/2"	9/16"	2-3/8"	4	5/8"	4	1/2"	3	3/16"	1-1/4
3/4"	360-9/16-PAFR	1-3/8"	3-7/8"	9/16"	2-3/4"	4	5/8"	4	1/2"	3	3/16"	1-1/2
1"	357-9/16-PAFR	1-5/8"	4-1/4"	9/16"	3-1/8"	4	5/8"	4	1/2"	3	3/16"	1-3/4
1-1/4"	358-12/16-PAFR	2"	4-5/8"	3/4"	3-1/2"	4	5/8"	4	1/2"	4	3/16"	2-1/2
1-1/2"	359-12/16-PAFR	2-1/4"	5"	3/4"	3-7/8"	4	5/8"	4	1/2"	4	3/16"	3-1/4
2"	268-12/16-PAFR	2-3/4"	6"	3/4"	4-3/4"	4	3/4"	4	5/8"	4	3/16"	4-1/2
2-1/2"	182-15/16-PAFR	3-1/4"	7"	15/16"	5-1/2"	4	3/4"	4	5/8"	5	3/16"	8-1/4
3"	172-15/16-PAFR	3-7/8"	7-1/2"	15/16"	6"	4	3/4"	4	5/8"	5	3/16"	10
4"	149-15/16-PAFR	4-7/8"	9"	15/16"	7-1/2"	8	3/4"	8	5/8"	5	3/16"	11-1/4
5"	292-15/16-PAFR	6-1/16"	10"	15/16"	8-1/2"	8	7/8"	8	3/4"	5	3/16"	12-1/2
6"	126-15/16-PAFR	7-1/8"	11"	15/16"	9-1/2"	8	7/8"	8	3/4"	5	3/16"	18-1/2
8"	144-9/8-PAFR	9-3/16"	13-1/2"	1-1/8"	11-3/4"	8	7/8"	8	3/4"	3	3/8"	28
10"	150-12/8-PAFR	11-3/8"	16"	1-1/2"	14-1/4"	12	1"	12	7/8"	4	3/8"	46
12"	152-12/8-PAFR	13-1/2"	19"	1-1/2"	17"	12	1"	12	7/8"	4	3/8"	66
14"	184-12/8-PAFR	14-3/4"	21"	1-1/2"	18-3/4"	12	1-1/8"	12	1"	4	3/8"	72
16"	175-12/8-PAFR	16-3/4"	23-1/2"	1-1/2"	21-1/4"	16	1-1/8"	16	1"	4	3/8"	85
18"	176-12/8-PAFR	18-3/4"	25"	1-1/2"	22-3/4"	16	1-1/4"	16	1-1/8"	4	3/8"	88
20"	177-15/8-PAFR	20-3/4"	27-1/2"	1-7/8"	25"	20	1-1/4"	20	1-1/8"	5	3/8"	132
24"	325-15/8-PAFR	24-7/8"	32"	1-7/8"	29-1/2"	20	1-3/8"	20	1-1/4"	5	3/8"	154
30"	326-18/8-PAFR	30-7/8"	38-3/4"	2-1/4"	36"	28	1-3/8"	28	1-1/4"	6	3/8"	249

THE MARZOLF COMPANY

PHONE 715.426.5705 | FAX 715.426.5708
 E-MAIL INFO@MARZOLF.COM
 WWW.MARZOLF.COM

Zinc Plated Carbon Steel — For Pipe Angle Face Rings

T-316L Stainless Steel — Class 300 Bolt Hole Pattern

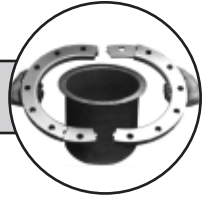

• **Class 300** •

Size	Part No.	Inside Diameter I.D.	Outside Diameter O.D.	Thickness T.	Radius	Bolt Circle B.C.	Holes H.D.		Bolts		Plies		Shipping Weight Lbs.
							No.	Dia.	No.	Size	No.	Ga.	
1/2	3612-300-RIPS	.90"	3-3/4"	3/4"	1/8"	2-5/8"	4	5/8"	4	1/2"	5	1/8"	3
3/4"	3602-300-RIPS	1.11"	4-5/8"	3/4"	1/8"	3-1/4"	4	3/4"	4	5/8"	5	1/8"	3
1"	3572-300-RIPS	1.38"	4-7/8"	3/4"	1/8"	3-1/2"	4	3/4"	4	5/8"	6	1/8"	3
1-1/4"	3582-300-RIPS	1.72"	5-1/4"	3/4"	3/16"	3-7/8"	4	3/4"	4	5/8"	6	1/8"	4
1-1/2"	3592-300-RIPS	1.97"	6-1/8"	3/4"	1/4"	4-1/2"	4	7/8"	4	3/4"	6	1/8"	6
2"	2682-300-RIPS	2.46"	6-1/2"	1"	5/16"	5"	8	3/4"	8	5/8"	8	1/8"	7
2-1/2"	1822-300-RIPS	2.97"	7-1/2"	1"	5/16"	5-7/8"	8	7/8"	8	3/4"	8	1/8"	10
3"	1722-300-RIPS	3.60"	8-1/4"	1-1/8"	3/8"	6-5/8"	8	7/8"	8	3/4"	3	3/8"	13
4"	1492-300-RIPS	4.60"	10"	1-1/2"	7/16"	7-7/8"	8	7/8"	8	3/4"	4	3/8"	22
5"	2922-300-RIPS	5.69"	11"	1-1/2"	7/16"	9-1/4"	8	7/8"	8	3/4"	4	3/8"	28
6"	1262-300-RIPS	6.75"	12-1/2"	1-1/2"	1/2"	10-5/8"	12	7/8"	12	3/4"	4	3/8"	39
8"	1442-300-RIPS	8.75"	15"	1-1/2"	1/2"	13"	12	1"	12	7/8"	4	3/8"	58
10"	1502-300-RIPS	10.92"	17-1/2"	1-7/8"	1/2"	15-1/4"	16	1-1/8"	16	1"	5	3/8"	82
12"	1522-300-RIPS	12.92"	20-1/2"	1-7/8"	1/2"	17-3/4"	16	1-1/4"	16	1-1/8"	5	3/8"	115
14"	1842-300-RIPS	14.18"	23"	2-1/4"	1/2"	20-1/4"	20	1-1/4"	20	1-1/8"	6	3/8"	163
16"	1752-300-RIPS	16.19"	25-1/2"	2-1/4"	1/2"	22-1/2"	20	1-3/8"	20	1-1/4"	6	3/8"	220
18"	1762-300-RIPS	18.20"	28"	2-1/4"	1/2"	24-3/4"	24	1-3/8"	24	1-1/4"	6	3/8"	280
20"	1772-300-RIPS	20.25"	30-1/2"	2-5/8"	1/2"	27"	24	1-3/8"	24	1-1/4"	7	3/8"	325
24"	3252-300-RIPS	24.25"	36"	2-5/8"	1/2"	32"	24	1-5/8"	24	1-1/2"	7	3/8"	492
30"	3262-300-RIPS	30.25"	43"	3-3/8"	1/2"	39-1/4"	28	1-7/8"	28	1-3/4"	9	3/8"	779



PHONE 715.426.5705 | FAX 715.426.5708

E-MAIL INFO@MARZOLF.COM

WWW.MARZOLF.COM

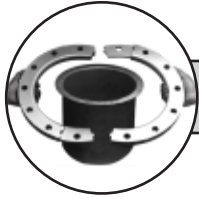

Zinc Plated Carbon Steel — Class 300 Bolt Hole Pattern

• Class 300 •

Size	Part No.	Inside	Outside	Thickness	Radius	Bolt	Holes		Bolts		Plies		Shipping
		Diameter	Diameter				Bolt	No.	Dia.	No.	Size	No.	
		I.D.	O.D.	T.		B.C.	No.	Dia.	No.	Size	No.	Ga.	Lbs.
1/2"	361-300-RIPS	.90"	3-3/4"	3/4"	1/8"	2-5/8"	4	5/8"	4	1/2"	4	3/16"	3
3/4"	360-300-RIPS	1.11"	4-5/8"	3/4"	1/8"	3-1/4"	4	3/4"	4	5/8"	4	3/16"	3
1"	357-300-RIPS	1.38"	4-7/8"	3/4"	1/8"	3-1/2"	4	3/4"	4	5/8"	4	3/16"	3
1-1/4"	358-300-RIPS	1.72"	5-1/4"	3/4"	3/16"	3-7/8"	4	3/4"	4	5/8"	4	3/16"	4
1-1/2"	359-300-RIPS	1.97"	6-1/8"	3/4"	1/4"	4-1/2"	4	7/8"	4	3/4"	5	3/16"	6
2"	268-300-RIPS	2.46"	6-1/2"	15/16"	5/16"	5"	8	3/4"	8	5/8"	5	3/16"	7
2-1/2"	182-300-RIPS	2.97"	7-1/2"	15/16"	5/16"	5-7/8"	8	7/8"	8	3/4"	5	3/16"	10
3"	172-300-RIPS	3.60"	8-1/4"	1-1/8"	3/8"	6-5/8"	8	7/8"	8	3/4"	3	3/8"	13
4"	149-300-RIPS	4.60"	10"	1-1/2"	7/16"	7-7/8"	8	7/8"	8	3/4"	4	3/8"	22
5"	292-300-RIPS	5.69"	11"	1-1/2"	7/16"	9-1/4"	8	7/8"	8	3/4"	4	3/8"	28
6"	126-300-RIPS	6.75"	12-1/2"	1-1/2"	1/2"	10-5/8"	12	7/8"	12	3/4"	4	3/8"	39
8"	144-300-RIPS	8.75"	15"	1-1/2"	1/2"	13"	12	1"	12	7/8"	4	3/8"	58
10"	150-300-RIPS	10.92"	17-1/2"	1-7/8"	1/2"	15-1/4"	16	1-1/8"	16	1"	5	3/8"	82
12"	152-300-RIPS	12.92"	20-1/2"	1-7/8"	1/2"	17-3/4"	16	1-1/4"	16	1-1/8"	5	3/8"	115
14"	184-300-RIPS	14.18"	23"	2-1/4"	1/2"	20-1/4"	20	1-1/4"	20	1-1/8"	6	3/8"	163
16"	175-300-RIPS	16.19"	25-1/2"	2-1/4"	1/2"	22-1/2"	20	1-3/8"	20	1-1/4"	6	3/8"	220
18"	176-300-RIPS	18.20"	28"	2-1/4"	1/2"	24-3/4"	24	1-3/8"	24	1-1/4"	6	3/8"	280
20"	177-300-RIPS	20.25"	30-1/2"	2-5/8"	1/2"	27"	24	1-3/8"	24	1-1/4"	7	3/8"	325
24"	325-300-RIPS	24.25"	36"	2-5/8"	1/2"	32"	24	1-5/8"	24	1-1/2"	7	3/8"	492
30"	326-300-RIPS	30.25"	43"	3-3/8"	1/2"	39-1/4"	28	1-7/8"	28	1-3/4"	9	3/8"	779

**THE
MARZOLF
COMPANY**

PHONE 715.426.5705 | FAX 715.426.5708

E-MAIL INFO@MARZOLF.COM

WWW.MARZOLF.COM

Zinc Plated Carbon Steel — Class 300 Bolt Hole Pattern

WELDED FLANGE LAMINATIONS INTERLEAVE
FOR RIGID ASSEMBLY AND EASY DISASSEMBLY

THE TWO HALVES SHARE COMMON BOLT HOLES
WHEN ASSEMBLED TO MAINTAIN UNIFORM FLANGE
RIGIDITY.

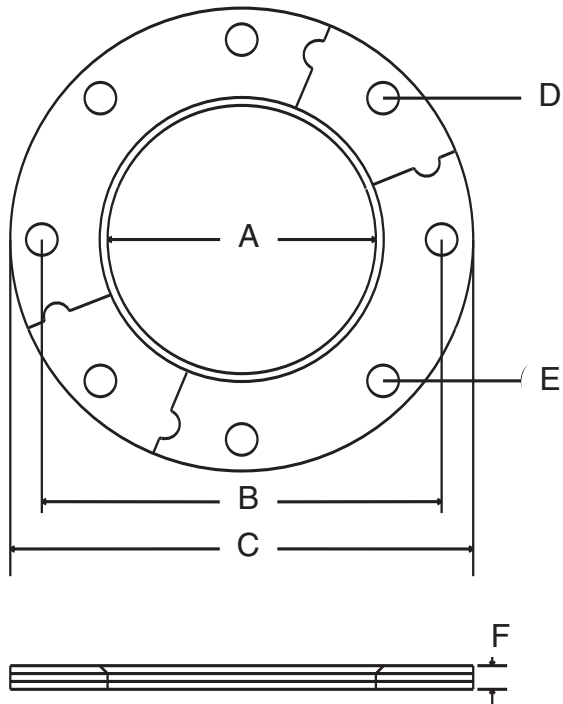

- A Inside Diameter (I.D.)
- B Bolt Circle (B.C.)
- C Outside Diameter (O.D.)
- D Common Bolt Holes (2)
- E Bolt Hole Diameter (B.H.D.)
- F Thickness

BOLTING SEQUENCE (Drawings Not to Scale)

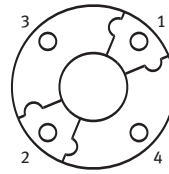

4 - HOLE RING

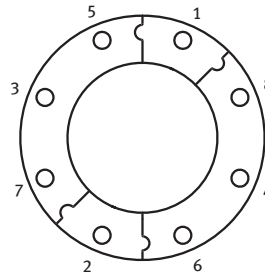

8 - HOLE RING

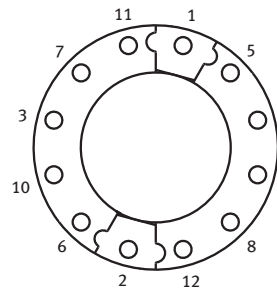

12 - HOLE RING

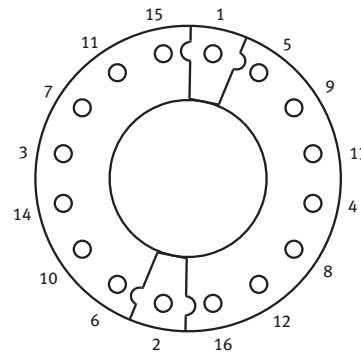

16 - HOLE RING

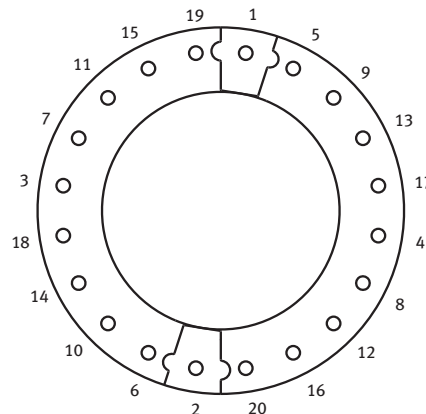

20 - HOLE RING

STUB ENDS

STUB ENDS MATE UP FLUSH WITH PIPE OR
TUBE ENDS

STUB END OD IS THE SAME AS TUBE/PIPE OD;
THEREFORE RING I.D. WILL BE BORED TO FIT

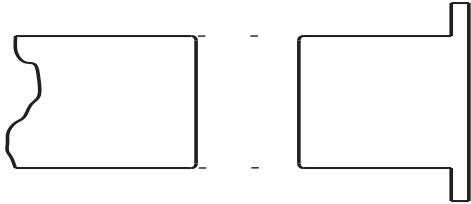

ANGLE FACE RING

ANGLE FACE RING SLIDES OVER PIPE TO FORM
MALE/FEMALE TYPE FIT

END OD IS GREATER THAN TUBE/PIPE OD;
THEREFORE RING I.D. IS OVERBORED TO FIT

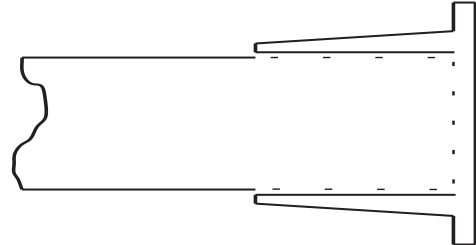

STUB END TYPES

TYPE A



TYPE B

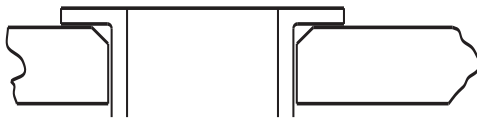

TYPE C



STOCK MATERIALS INCLUDE

T-316L

ASTM A-36

RAPID TURNAROUND ON MOST
NON-STOCK ITEMS/MATERIALS

1 RING = 1 UNIT

2 RINGS = SET

PLEASE ORDER PER RING

MARZOLF TWO-PIECE BACK-UP FLANGES

MADE OF:

- ▶ STAINLESS STEEL
- ▶ CARBON STEEL
ZINC-PLATED
E-COAT
TEFLON COAT
- ▶ PVC & CPVC PLASTIC
- ▶ CUSTOM ALLOYS

TO FIT:

- ▶ TUBE/PIPE
- ▶ STUB ENDS
TYPE A, B, OR C
- ▶ ANGLE FACE RINGS
- ▶ POLYETHYLENE PIPE
- ▶ FIBERGLASS PIPE
- ▶ LINED PIPE
- ▶ PVC/CPVC PIPE
- ▶ BEADED END HOSE
- ▶ OTHERS

INCLUDES:

- ▶ CLASS 75
(ANSI CLASS 150
BOLT HOLE PATTERN)
- ▶ CLASS 150
- ▶ 1/2" - 30" IN STOCK
OVER 30" AVAILABLE
- ▶ CLASS 300
- ▶ REDUCING FLANGES
- ▶ METRIC
- ▶ DIN
- ▶ CUSTOM DESIGN &
FABRICATION

T H E
MARZOLF
C O M P A N Y

POST OFFICE BOX 281
N8705 COUNTY ROAD W, RIVER FALLS, WI 54022
PHONE > 715.426.5705 | FAX > 715.426.5708
E-MAIL > INFO@MARZOLF.COM
WWW.MARZOLF.COM